

KRUPP

**45 ton Capacity
All-Terrain-Crane**



KMK 3045

Courtesy of Crane.Market

Dimensions

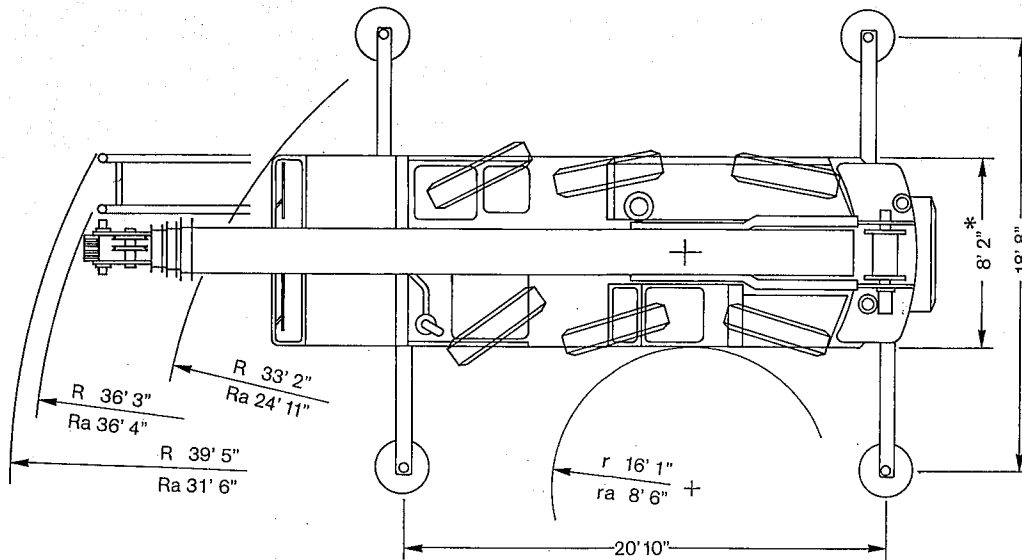
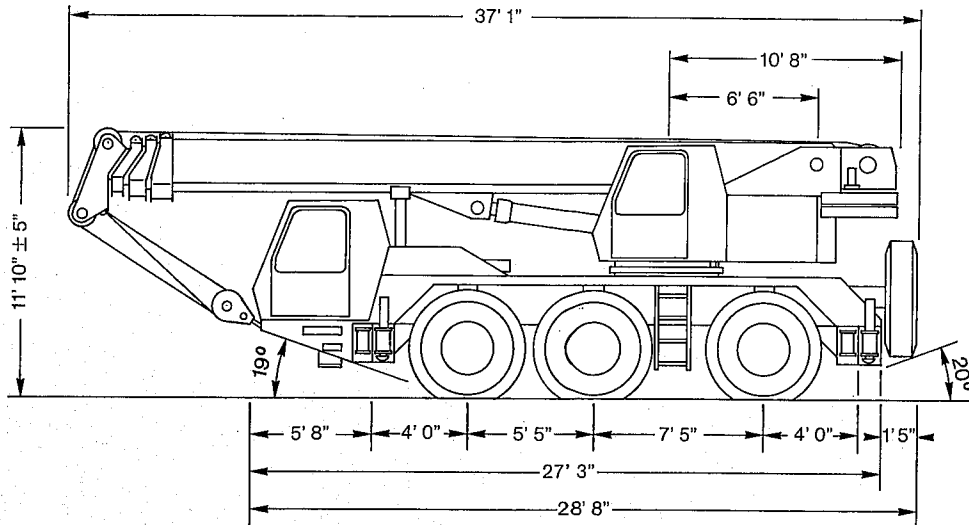

Ra, ra = Radius all wheel steer

* Standard tyres

Hook elevation diagram

Main boom and lattice extension

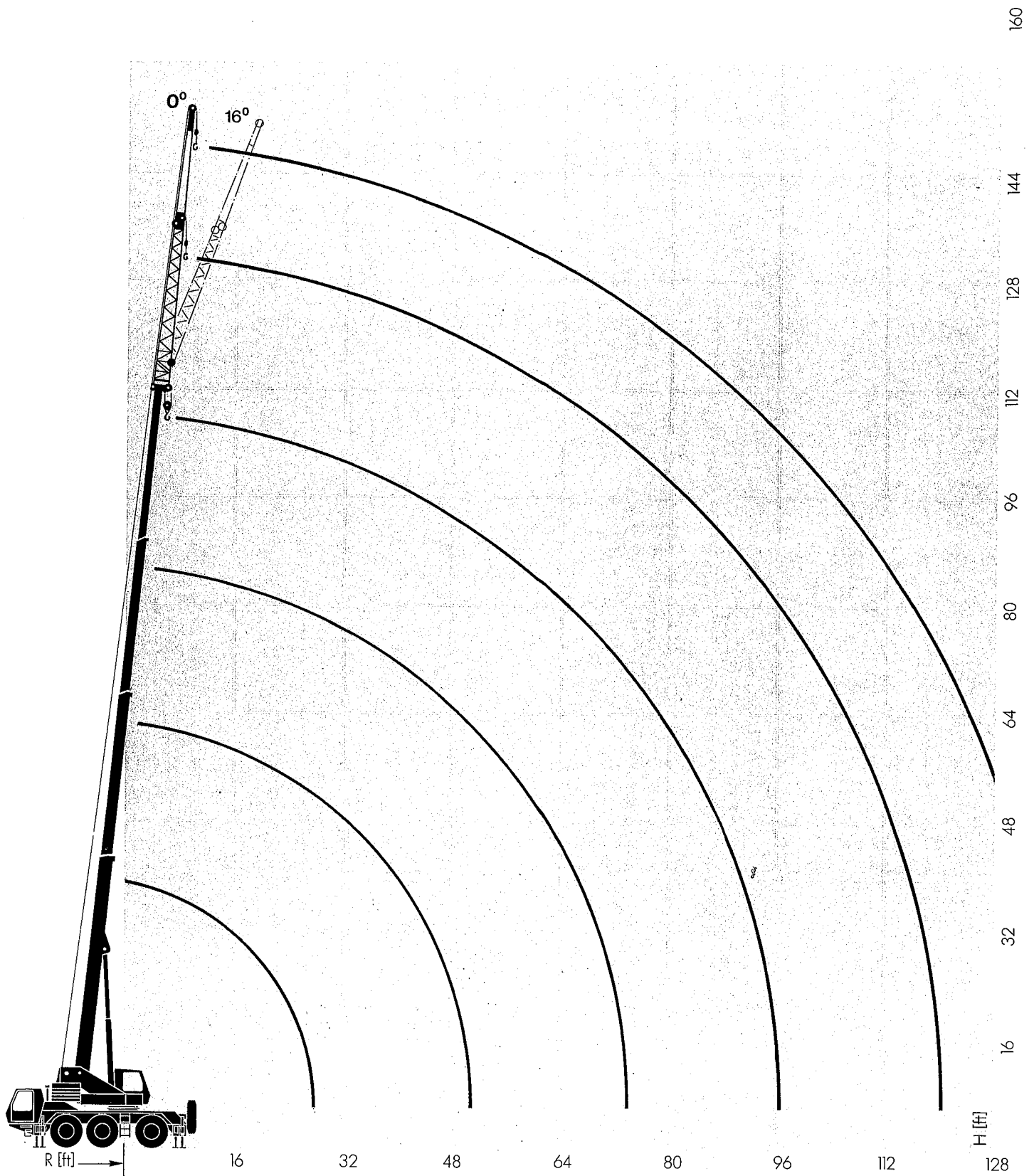

KMK 3045



Courtesy of Crane.Market

Main boom

Lifting capacities in 1000 lbs

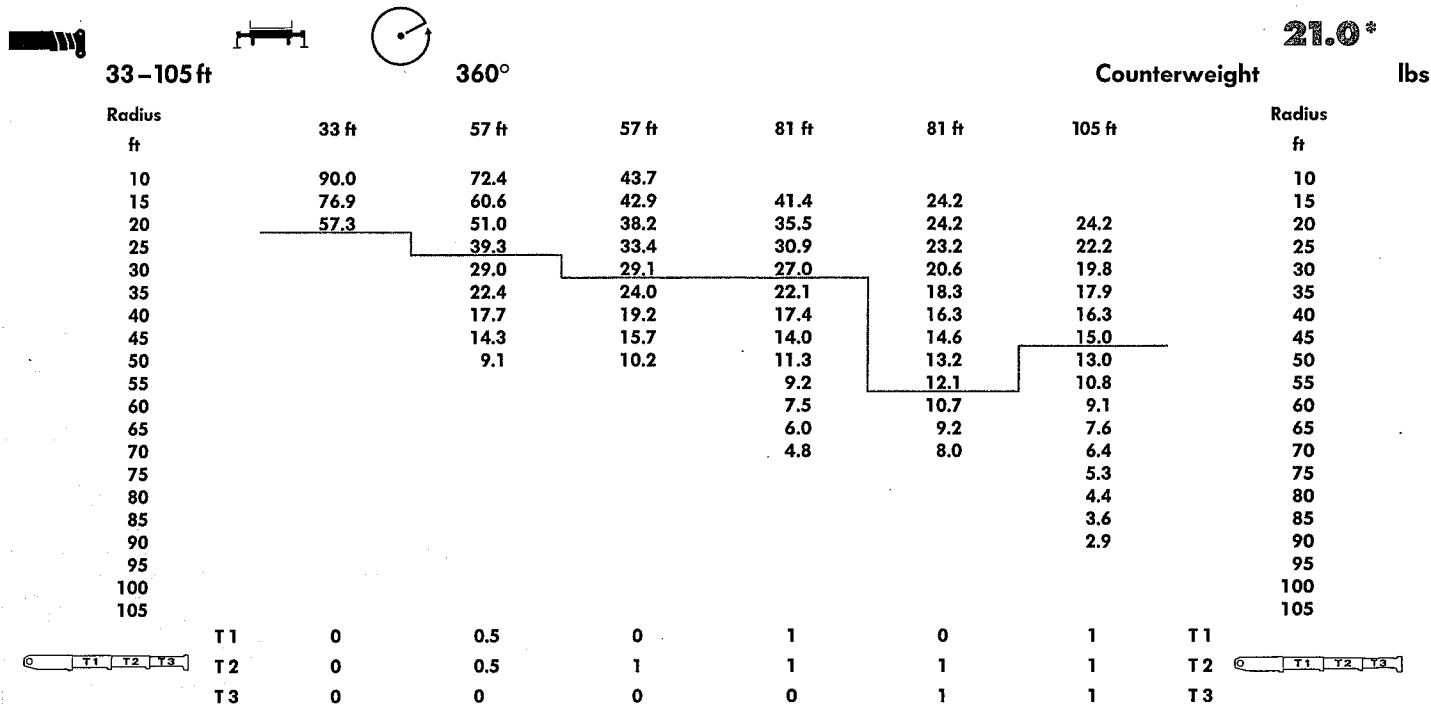

*1000 lbs

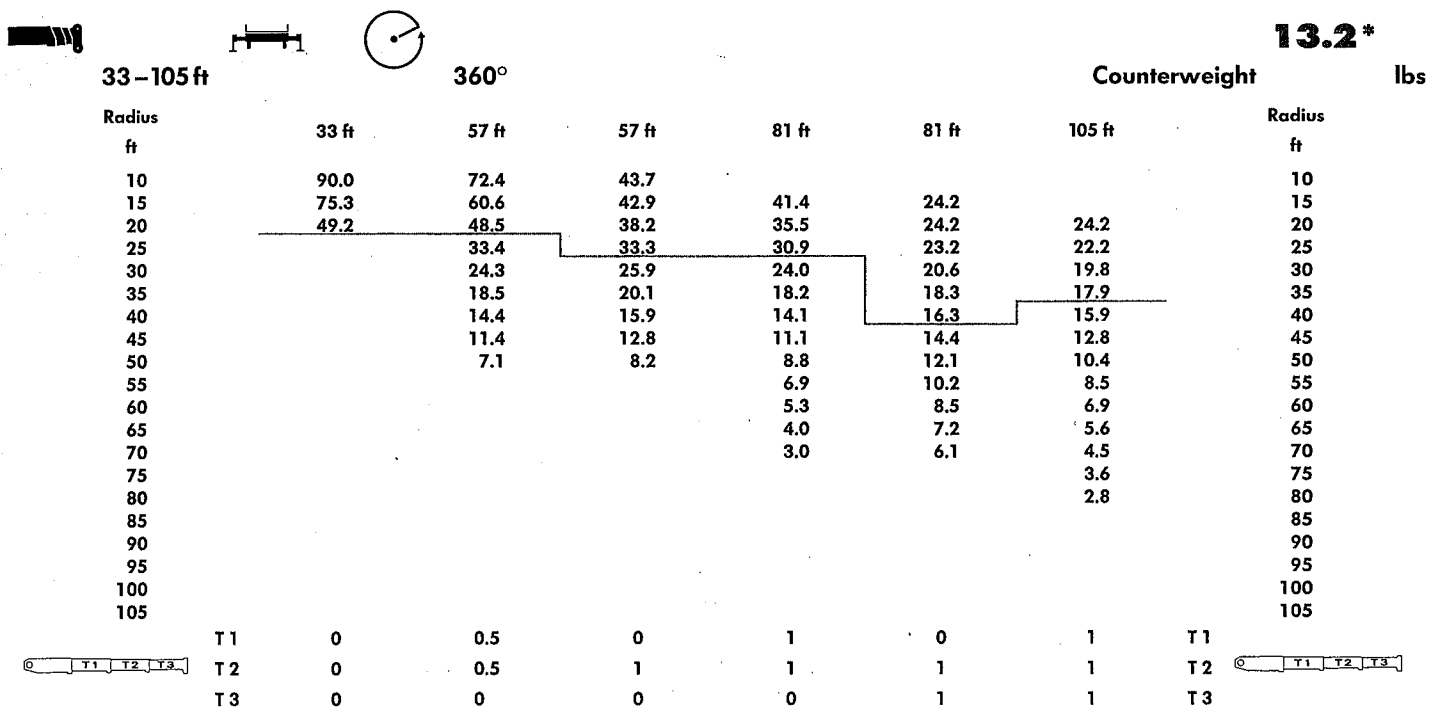

*1000 lbs

Main boom + swing-away extension

Lifting capacities in 1000 lbs



26-43 ft



360°

21.0*

Counterweight lbs

Radius

Main boom length
94 ft

Radius

Lattice extension length 26 ft

Lattice extension length 43 ft

ft	120 ft		117 ft		137 ft		134 ft		ft
	0°	16°	0°	16°	0°	16°	0°	16°	
30	14.6	12.1	8.2	7.9	7.3	7.1	6.8	6.5	30
35	14.3	12.1	7.9	7.6	7.3	7.1	6.8	6.5	35
40	13.5	11.8	7.6	7.3	7.0	6.8	6.5	6.2	40
45	12.6	11.2	7.3	7.0	6.7	6.5	6.2	6.0	45
50	11.9	10.6	7.0	6.7	6.4	6.2	6.0	5.7	50
55	10.6	10.0	6.7	6.4	6.2	6.0	5.7	5.5	55
60	8.8	8.8	6.4	6.2	5.9	5.7	5.5	5.3	60
65	7.4	7.4	6.2	5.9	5.7	5.5	5.3	5.1	65
70	6.1	6.1	5.9	5.7	5.5	5.3	5.1	4.9	70
75	5.0	5.0	5.7	5.5	5.3	5.1	4.9	4.7	75
80	4.1	4.1	5.3	5.1	4.9	4.7	4.5	4.3	80
85	3.3	3.3	4.5	4.3	4.1	3.9	3.7	3.5	85
90	2.6	2.6	3.8	3.6	3.4	3.2	3.0	2.8	90
95			3.1	2.9	2.7	2.5	2.3	2.1	95
100									100

T1

1

1

1

1

T1

T2

1

1

1

1

T2

T3

0.5

0.5

0.5

0.5

T3

*1000 lbs



26-43 ft



360°

13.2*

Counterweight lbs

Radius

Main boom length
94 ft

Radius

Lattice extension length 26 ft

Lattice extension length 43 ft

ft	120 ft		117 ft		137 ft		134 ft		ft
	0°	16°	0°	16°	0°	16°	0°	16°	
30	14.6	12.1	8.2	7.9	7.3	7.1	6.8	6.5	30
35	14.3	12.1	7.9	7.6	7.3	7.1	6.8	6.5	35
40	13.5	11.8	7.6	7.3	7.0	6.8	6.5	6.2	40
45	12.4	11.2	7.3	7.0	6.7	6.5	6.2	6.0	45
50	10.3	10.3	7.0	6.7	6.4	6.2	6.0	5.7	50
55	8.4	8.4	6.7	6.4	6.2	6.0	5.7	5.5	55
60	6.8	6.8	6.4	6.2	5.9	5.7	5.5	5.3	60
65	5.4	5.4	6.2	5.9	5.7	5.5	5.3	5.1	65
70	4.3	4.3	5.5	5.3	5.1	4.9	4.7	4.5	70
75	3.3	3.3	4.5	4.3	4.1	3.9	3.7	3.5	75
80	2.5	2.5	3.7	3.5	3.3	3.1	2.9	2.7	80
85			3.0	2.8	2.6	2.4	2.2	2.0	85
90									90
95									95
100									100

T1

1

1

1

1

T1

T2

1

1

1

1

T2

T3

0.5

0.5

0.5

0.5

T3

*1000 lbs

Main boom + swing-away extension

Lifting capacities in 1000 lbs



26-43 ft



360°

Counterweight **21.0*** lbs

Radius ft	Main boom length 105 ft				Radius ft
	Lattice extension length 26 ft		Lattice extension length 43 ft		
	131 ft 0°	130 ft 16°	148 ft 0°	146 ft 16°	
40	9.7		6.1		40
45	9.7	8.5	6.1		45
50	9.6	8.4	6.1	5.6	50
55	9.0	8.1	6.1	5.4	55
60	8.5	7.7	5.9	5.2	60
65	7.6	7.3	5.7	4.9	65
70	6.3	6.3	5.5	4.7	70
75	5.3	5.3	5.4	4.5	75
80	4.3	4.3	5.2	4.4	80
85	3.5	3.5	4.6	4.4	85
90	2.8	2.8	3.9	3.9	90
95			3.2	3.2	95
100					100
105					105
110					110
T1	1	1	1	1	T1
T2	1	1	1	1	T2
T3	1	1	1	1	T3

*1000 lbs



26-43 ft



360°



Counterweight **13.2*** lbs

Radius ft	Main boom length 105 ft				Radius ft
	Lattice extension length 26 ft		Lattice extension length 43 ft		
	131 ft 0°	130 ft 16°	148 ft 0°	146 ft 16°	
40	9.7		6.1		40
45	9.7	8.5	6.1		45
50	9.6	8.4	6.1	5.6	50
55	8.6	8.1	6.1	5.4	55
60	7.0	7.0	5.9	5.2	60
65	5.6	5.6	5.7	4.9	65
70	4.5	4.5	5.4	4.7	70
75	3.5	3.5	4.6	4.5	75
80			3.8	3.8	80
85			3.1	3.1	85
90					90
95					95
100					100
105					105
110					110
T1	1	1	1	1	T1
T2	1	1	1	1	T2
T3	1	1	1	1	T3

*1000 lbs

Main boom – free on wheels

Lifting capacities in 1000 lbs

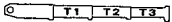
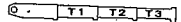
									
33 – 57 ft		0°							21,0*
	Radius							Counterweight	lbs
	ft	33 ft		57 ft				Radius	
	10	23.0		23.0				ft	
	15	13.9		14.3				10	
	20	11.0		11.4				15	
	25			7.5				20	
	30			5.9				25	
	35			3.7				30	
				0				35	
	T1	0		0				T1	
	T2	0		1				T2	
	T3	0		0				T3	

*1000 lbs

Notes for lifting capacities

Load capacities above bold line are based on structural strength, and tipping must not be relied upon as a limitation of lifting capacity.

Rated loads must not be exceeded.

Rated loads do not exceed 85% of tipping load with the machine properly levelled on firm ground.

360° duties – on outriggers fully extended.

Note counterweight required as listed in relevant lifting capacity columns.

For safe crane operation due allowance must be made to compensate for high winds, side load, pendulum action and other hazardous conditions. No side pull permitted.

Hook blocks, slings and / or boom attachments are considered part of load, and their weight must be deducted from the rated lifting capacity to determine the net load.

Boom must be extended in accordance with sequence as noted on lifting capacity chart.

Consult crane manual to determine weight reduction for load handling devices and boom attachments.

Operate crane strictly in compliance with operator's manual.

Weights / Working speeds



Axle	1	2	3	Total weight
1000 lbs	26.5	26.5	26.5	79,5*

* incl. 13.200 lbs counterweight



Lifting capacity (tons)	Sheaves	Parts of line	Weight lbs
30	3	1 - 7	770
12	1	1 - 3	400

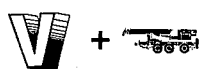

Gear	1	2	3	4	5	6	R1	R2	Gradeability max.
On-road (mp/h)	4.7	8.3	10.9	19.1	23.9	42.0	4.7	10.9	50%

Tyres 14.00 R 25

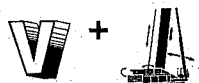

Drives	infinately variable	Rope diameter / Rope length	Max. single line pull
Main hoist	0 - 460 ft / min. single line	16 mm (5/8") / 560 ft	9700 lbs
Auxiliary hoist	0 - 460 ft / min. single line	16 mm (5/8") / 560 ft	9700 lbs
Swing gear	0 - 2.5 min ⁻¹		
Boom elevation	approx. 45 seconds to reach from -3° to +84° boom angle		
Telescoping	approx. 100 seconds for boom length from 33 - 105 ft		

 Telescopic boom

 On outriggers

 Working range

 Axle load

 Hook blocks and hook

 Crane motion

 Speed

 Swing-away lattice

 free on wheels

Carrier

Chassis:	Special KRUPP 3-axle carrier, all-welded torsion-resistant box-type construction in high strength steel.
Outriggers:	4 hydraulically telescoping beams with vertical cylinders and outrigger pads. Independent horizontal and vertical movement control on each side of the chassis. Levelling device.
Engine:	Mercedes-Benz OM 442 diesel, 8 cylinders, water-cooled, 221 kW (300 HP) at 2100 min ⁻¹ (DIN 6271 IFN). Max. torque: 1100 Nm (112,1 kp) at 1100–1500 min ⁻¹ . Tank capacity: approx. 80 gal.
Transmission:	ZF 6-gear powershift 6 WG 200 with integrated transfer case, and front axle drive disconnect.
Axle lines:	3 axle lines. Axle lines 1 and 3 are drive steer axle lines, 2nd axle steering only, 6x4 steering mode for highway travel, 6x6 steering mode off-road.
Suspension:	All axle lines hydropneumatic suspension. Level control. Suspension range $\pm 5^\circ$. Possible combinations for transverse slope.
Tyres:	6 tyres, 14.00 R 25.
Steering:	ZF, dual-circuit, hydraulic power assisted steering.
Brakes:	Service brake: pneumatic dual-circuit, acting on all wheels. Permanent brake: exhaust brake. Hand brake: pneumatically operated spring-loaded brake acting on 2nd and 3rd axle line.
Driver's cab:	Aluminium, 2-man-design, safety glass, driver's seat with hydraulic suspension, engine hot-water heating. Complete instrumentation and driving controls.
Electrical system:	Three-phase generator 28V/55 A, 2 batteries 12V/143 Ah, lighting system and signals.

Superstructure

Frame:	KRUPP-made, torsion-resistant welded construction in high strength steel.
Engine:	See carrier.
Hydraulic system:	3 separate circuits. Tank capacity: 150 gal., 2 variable displacement pumps, flange mounted gear pumps.
Control system:	Infinite variation of all crane movements by control levers with automatic reset to zero.
Main hoist:	Axial-piston motor with planetary gear and automatic multiple-disc brake.
Boom elevation:	1 cylinder with safety holding valve, boom angle from -3° to $+84^\circ$.
Swing gear:	Vane motor, planetary gear, and holding brake as well as multiple-disc brake.
Cab:	Aluminium, full vision, safety glass, adjustable operator's seat with hydraulic suspension, engine-independent heating, instrumentation and operating controls for carrier and superstructure.
Safety installations:	Hoist and lowering limit switch, pipe check valves, pressure relief valves.
Telescopic boom:	Welded construction in high strength steel, 1 base section, 3 telescopic sections. Total boom length: 105 ft, hydraulic full power.

Additional equipment

Tyres:	6 tyres, 16.00 R 25 (vehicle width 9'0").
Swing-away lattice:	2-stage, stowing alongside boom, 26–43 ft.
Aux. hoist:	2nd hoist gear.
Driver's cab:	Engine-independent heater with engine preheater.
Safe load indicator:	Electronic load moment safety device (type EKS 83) with automatic cut-out and digital display for actual and admissible load, radius and various working conditions.

Further options upon request.